

①

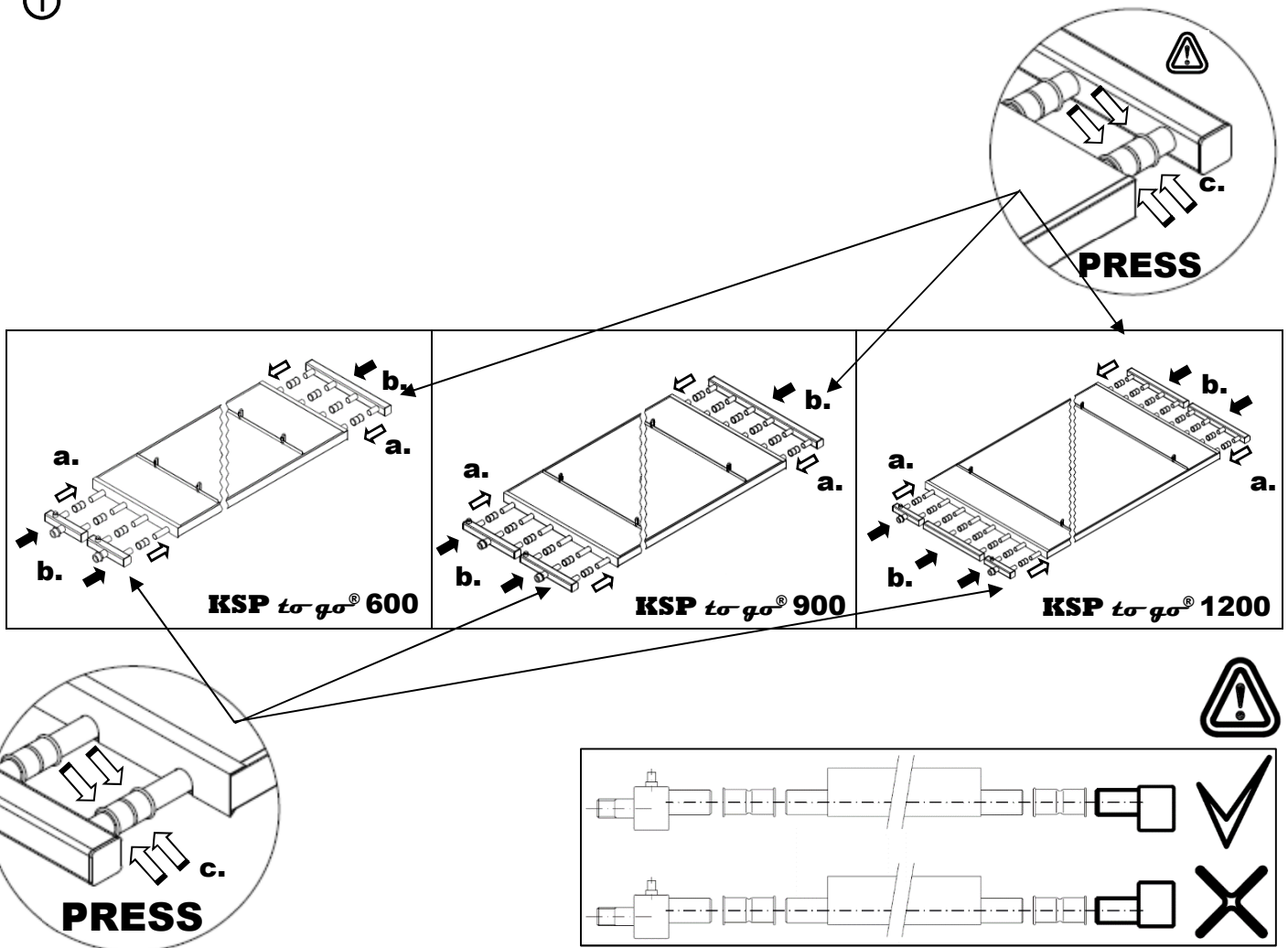

②

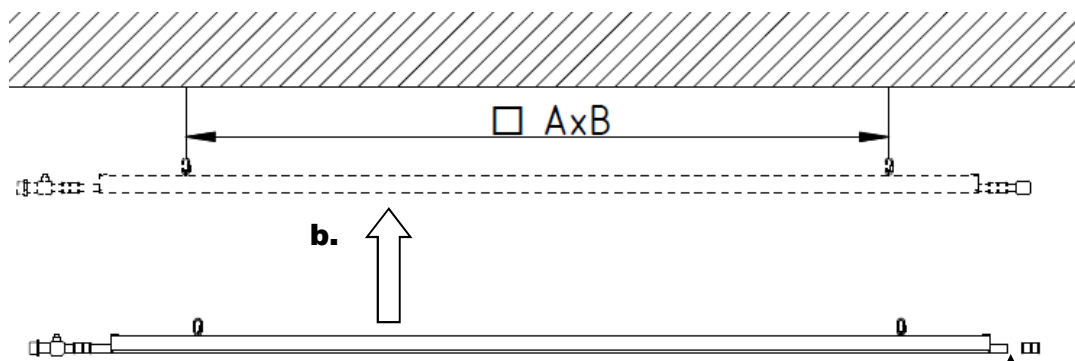

- Box 1.2 (**KSP to-go® 600/ 2m**) A = 1.600 mm; B = 450 mm
- Box 1.3 (**KSP to-go® 600/ 3m**) A = 2.600 mm; B = 450 mm
- Box 2.2 (**KSP to-go® 900/ 2m**) A = 1.600 mm; B = 750 mm
- Box 2.3 (**KSP to-go® 900/ 3m**) A = 2.600 mm; B = 750 mm
- Box 3.2 (**KSP to-go® 1200/ 2m**) A = 1.600 mm; B = 750 mm
- Box 3.3 (**KSP to-go® 1200/ 3m**) A = 2.600 mm; B = 750 mm

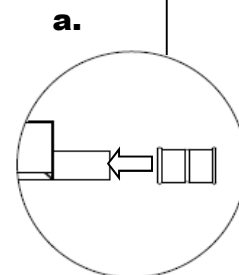

③

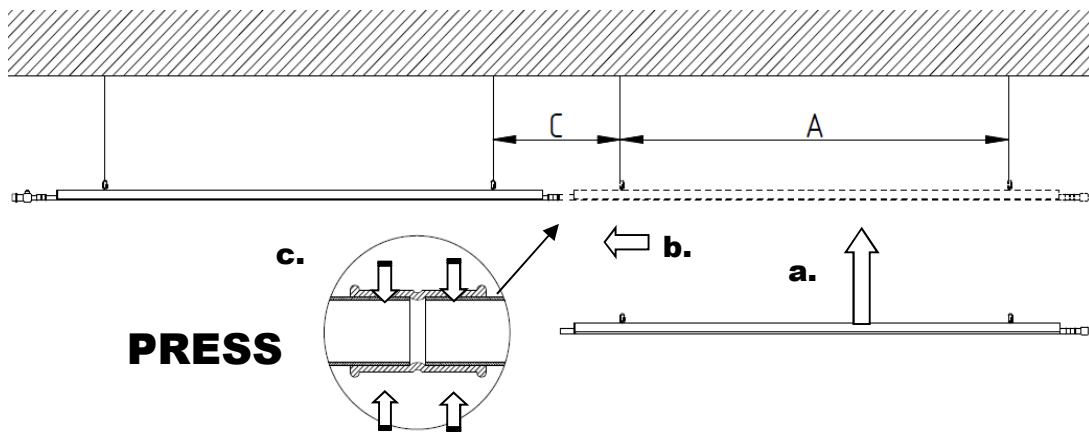

- Box 1.2 (KSP to-go® 600/ 2m)** A = 1.600 mm; C = 410 mm
- Box 1.3 (KSP to-go® 600/ 3m)** A = 2.600 mm; C = 410 mm
- Box 2.2 (KSP to-go® 900/ 2m)** A = 1.600 mm; C = 410 mm
- Box 2.3 (KSP to-go® 900/ 3m)** A = 2.600 mm; C = 410 mm
- Box 3.2 (KSP to-go® 1200/ 2m)** A = 1.600 mm; C = 410 mm
- Box 3.3 (KSP to-go® 1200/ 3m)** A = 2.600 mm; C = 410 mm

④

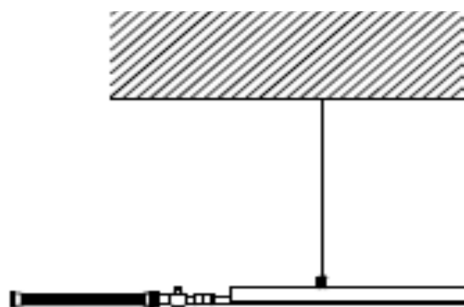

KSP to-go® 600

KSP to-go® 900

KSP to-go® 1200

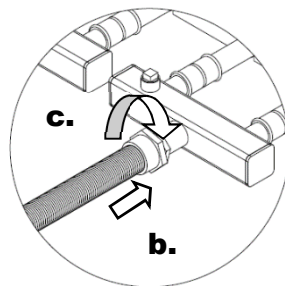
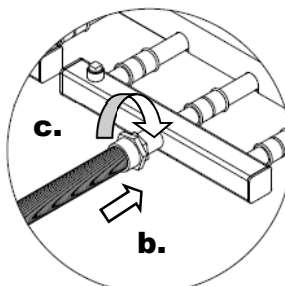
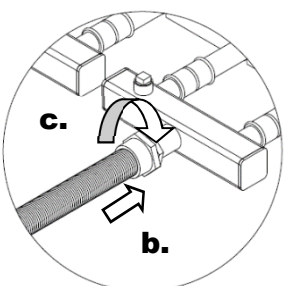
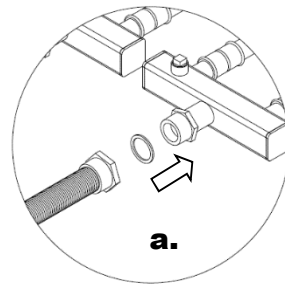
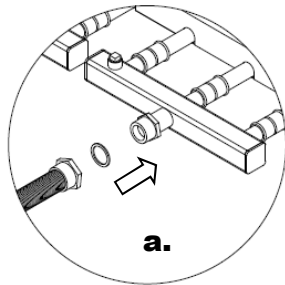
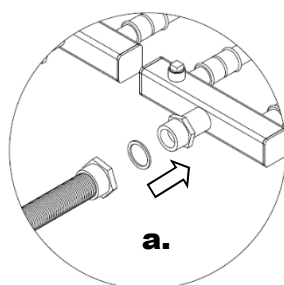

⑤

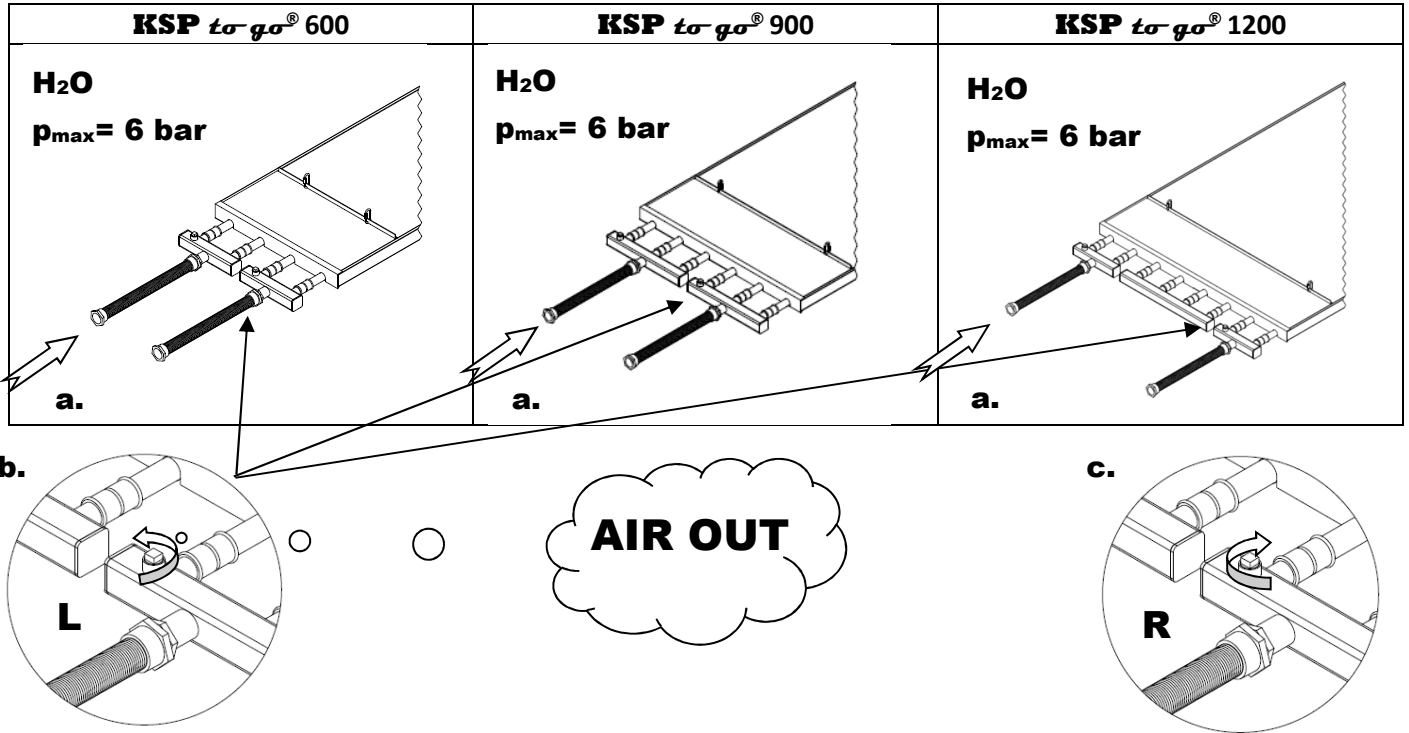

⑥

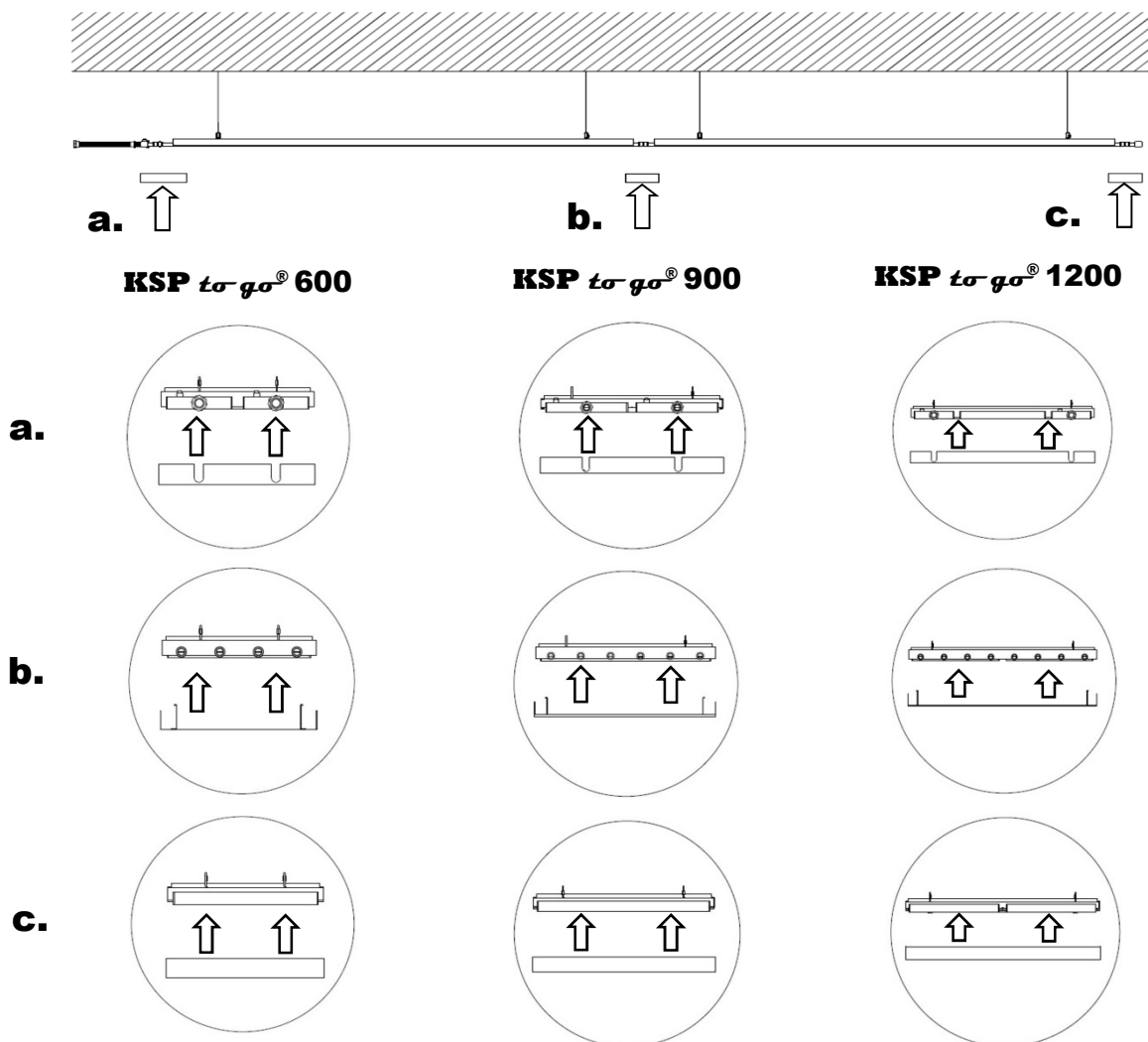

⑦

